



Lorna Collection

Colours represented are to be used as a guide only.
Please refer to manufacturers swatch for a more accurate colour match.

Please note that colour shadings can vary slightly from each roll of fabric.
We cannot guarantee a precise match to these samples or between cut lengths and upholstered goods.

foamflex™
Award Winning Seating Technology
23/01/2020

LORNA COVER GUIDE - STANDARD BACK

Please use this guide when ordering the following pieces to clarify cover options.

STANDARD BACK

LH3, RFC, FST (L3, RFC, P) Group

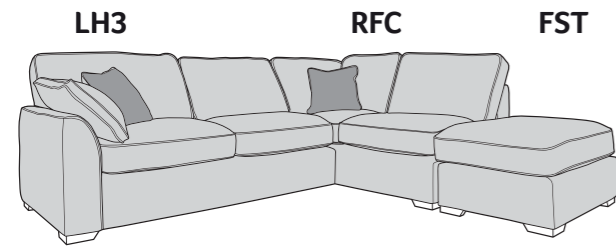

3 Seater Sofa (3ST)

FST, LFC, RH3 (P, LFC, R3) Group

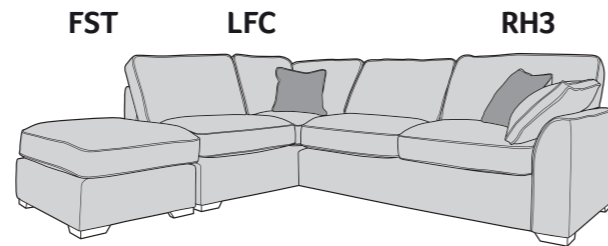

2 Seater Sofa (2ST)

K-End Sofa: LHK, RH2 (LK, R2)

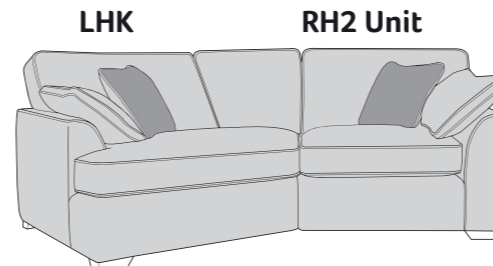

Love Chair (LOV)

K-End Sofa: LH2, RHK (L2, RK)

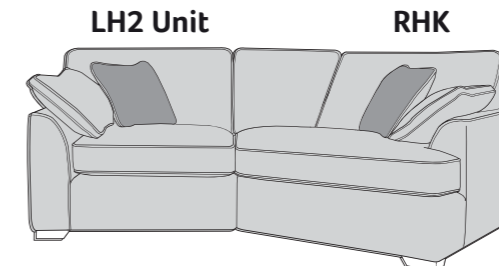

Arm Chair (1ST)

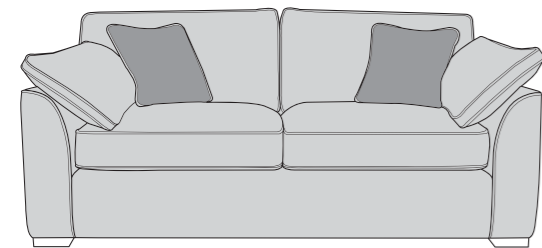

2 Seater Sofa Bed (2SB/2DB)

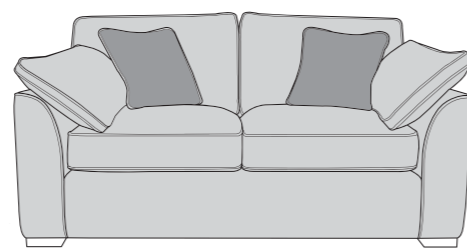

Luman Swivel Chair (SWC)

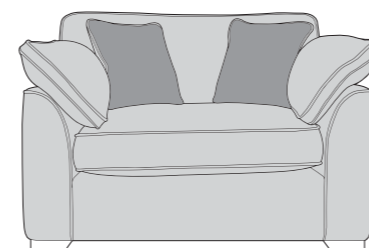

Cuddler Footstool (FST)

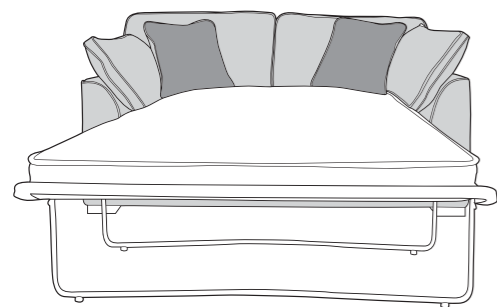

George Accent Chair (ACH)

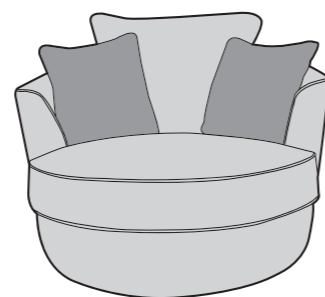

Large Footstool P (FST)

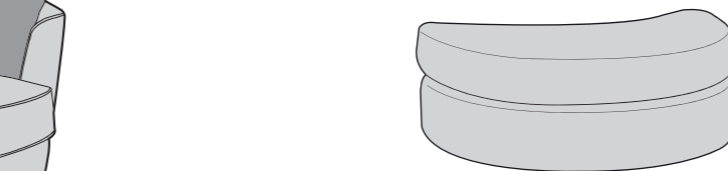

Storage Footstool (FSS)

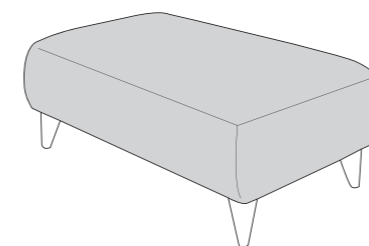

Large Style Footstool (FST)

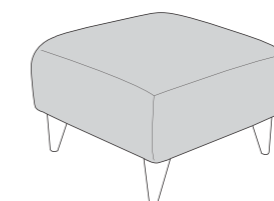

Small Style Footstool (FST)

ACCENT PIECES

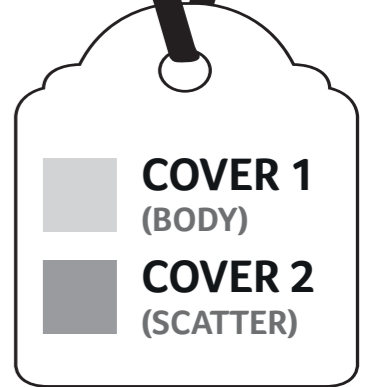

Scatter Cushions

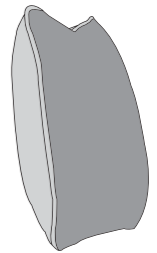

Front = Cover 2
Piping = Cover 1
Back = Cover 1

LORNA DIMENSIONS (CM)

AVAILABLE PIECES	HEIGHT 1	WIDTH 2	DEPTH 3	SEAT HEIGHT 4	SEAT DEPTH (STD) 5	SEAT WIDTH 6	ACCESS DIAGONAL 7	WEIGHT (KG)	SCATTER CUSHIONS	Angles
LH3, RFC, FST GROUP (L3, RFC, P) or RH3, LFC, FST GROUP (R3, LFC, P)	92	282	251	53	56	N/A	N/A	100.5	2	N/A
K-END SOFA: LH2, RHK GROUP (L2, RK) or RH2, LHK GROUP (R2, LK)	93	251	109	53	65	148	N/A	92	2	Front - 144° Joint - 189° K-end - 207°
K-END UNIT - LHK/RHK (LK/RK)	93	160	109	50	65	97	175	52.5	1	Front - 144° Joint - 189° K-end - 207°
LH3/RH3 UNIT (L3/R3)	92	186	96	53	56	149	204	53	1	N/A
LFC/RFC UNIT (LFC/RFC)	92	178	96	53	56	137	200	47.5	1	N/A
LH2/RH2 UNIT (L2/R2)	93	102	97	50	54	63	135	39.5	1	N/A
3 SEATER SOFA (3ST)										
3 SEATER SOFA (3ST)	93	203	97	50	54	127	218	70	2	N/A
2 SEATER SOFA (2ST)										
2 SEATER SOFA (2ST)	93	175	97	50	54	102	195	60	2	N/A
LOVE CHAIR (LOV)	93	136	97	50	56	63	160	52.5	2	N/A
ARM CHAIR (1ST)	93	101	97	50	54	66	133	43	1	N/A
SWIVEL CHAIR (SWC)	90	114	111	39	65	75	N/A	34	N/A	N/A
CUDDLER FOOTSTOOL (FST)	39	92	69	N/A	N/A	N/A	118	18	N/A	N/A
SOFA BEDS - STD BACK ONLY										
2SB - 120 STANDARD SOFA BED	93	175	97	50	56	99	193	73	2	N/A
2SD - 120 DELUXE SOFA BED	93	175	97	50	56	99	193	N/A	2	N/A
OPEN DEPTH OF SOFA BEDS 226CM										
ACCENT PIECES										
GEORGE ACCENT CHAIR (ACH)	80	67	78	47	50	N/A	84	12.5	N/A	N/A
LARGE FOOTSTOOL P (FST)	53	73	96	N/A	N/A	N/A	115	17	N/A	N/A
STORAGE FOOTSTOOL (FSS)	43	63	50	N/A	N/A	N/A	75	13	N/A	N/A
LARGE STYLE FOOTSTOOL (FST)	40	103	63	N/A	N/A	N/A	115	15	N/A	N/A
SMALL STYLE FOOTSTOOL (FST)	40	63	63	N/A	N/A	N/A	83	11.5	N/A	N/A

* Hardwood & composite board frame.

* Dowelled, screwed, glued & stapled joinery.

* Mid Oak & Dark Wood foot options.

* Fibre filled scatters included.

* Sumptuous feather filled arm pads for added comfort.

* Award winning foamflex seat interior with 5 year guarantee.

* Serpentine seat springs & silent wire.

* Superloop back springs.

DIMENSION GUIDE

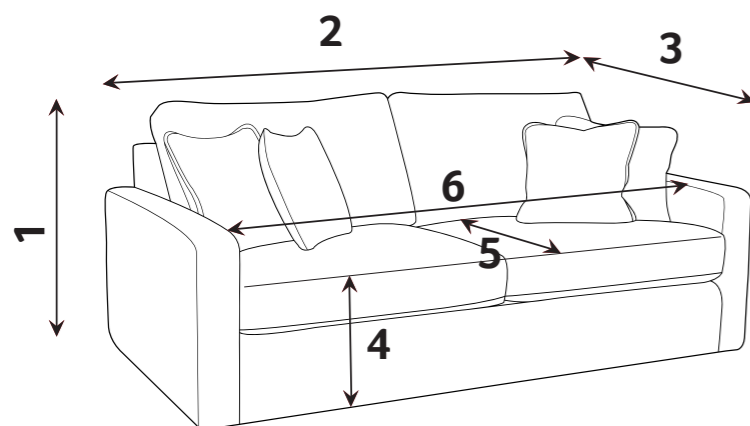

- 1 - HEIGHT
- 2 - WIDTH
- 3 - DEPTH
- 4 - SEAT HEIGHT
- 5 - SEAT DEPTH (STD & PILLOW)
- 6 - SEAT WIDTH
- 7 - DIAGONAL ACCESS

Check the diagonal access dimension to ensure furniture will fit in your home.

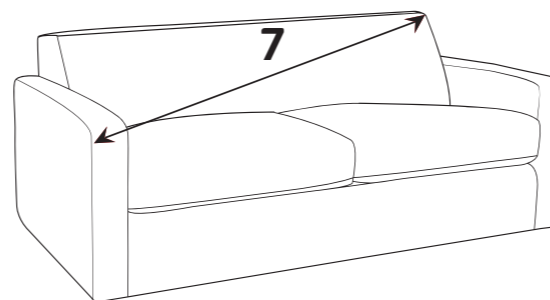

Illustrations used for reference only.

Please note : All dimensions are approximate. Allow tolerance of +/- 2.5cm.

SOFABEDS: 2 SLEEP OPTIONS

STANDARD ACTION & FOAM MATTRESS

A three fold metal action with a sprung 'polyprop' base. Complemented by a high performance foam mattress. For occasional use only.

Mattress Thickness: 6cm
Mattress Length: 185cm

3 fold action is 140Kg total max occupancy weight

120cm sofa bed:

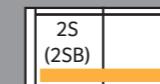

Mattress Width: 113cm



DELUXE ACTION & SPRUNG MATTRESS

A two fold metal action with beech slats. Complemented by a deluxe sprung mattress. For everyday use.

Mattress thickness: 11.5cm
Mattress Length: 183cm

2 fold action is 160Kg total max occupancy weight

120cm sofa bed:

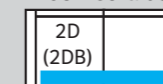

Mattress Width: 114cm



Sofa beds available as standard back only

foamflex

Our new, expertly engineered foam seat interior gives you the comfort of fibre with the retention of foam.

CARE GUIDE

To improve the longevity of your hand-made furniture, we recommend rotating cushions (where applicable). For further information on maintaining your furniture, please refer to the Care Guide located under the seat platform.



Our foamflex seat interiors have been granted the FIRA GOLD Award, a mark of quality under-pinning all necessary testing of the product materials, design and production techniques.

Convuluted Foam Topper

Doming Pad

High Density Base

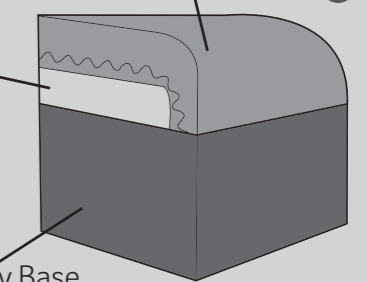

Mid Oak

Dark (Antique)

FOOT OPTIONS:



Wood is a natural product and will vary in shade/colour from item to item. Feet require fitting.



The mark of responsible forestry